

Typical Features

- ◆ Fixed input voltage, Isolated & unregulated, Output power 3W
- ◆ Efficiency up to 85% (Typ.)
- ◆ Mini size SIP packaging
- ◆ Isolation Voltage 3000VDC
- ◆ Operating Temperature from -40°C to +85°C
- ◆ Plastic Case, flame class UL94 V-0



Test Condition: Unless otherwise specified, all parameter values had been tested at nominal input voltage, pure resistive rated load, and at room temperature 25°C.

Application Field

This series of products can be widely used in the fields of instrument, communication, pure digital circuit, general low frequency analog circuit, relay drive circuit, data exchange circuit, etc.

Typical Product List

Certificate	Part No.	Input Voltage Range (VDC)		Output Voltage/Current (Vo/Io)		Input Current (mA) Typ. @Nominal Voltage		Max. Capacitive Load	Ripple & Noise (20MHz) Max/Typ.	Efficiency (%) @full load/nom. voltage	
		Nom.	Range	Vo (VDC)	Io(mA) Max/Min	Full Load	No Load			uF	mVp-p
CE	NN3-05S05C3N	5	4.5	5	600/60	665	12	1200	150/100	80	83
-	NN3-05S12C3N			12	250/30	650	18	560	150/100	80	83
-	NN3-05S15C3N		5.5	15	200/20	650	20	560	150/100	80	83
-	NN3-12S05C3N	12	10.8 - 13.2	5	600/60	295	12	1200	150/100	80	83
-	NN3-12S12C3N			12	250/30	290	12	560	150/100	81	84
-	NN3-12S15C3N			15	200/20	285	12	560	150/100	80	83
-	NN3-12S24C3N			24	125/13	285	12	470	150/100	80	83
-	NN3-24S05C3N	24	21.6 - 26.4	5	600/60	70	8	1200	150/100	80	83
-	NN3-24S12C3N			12	250/30	96	8	560	150/100	81	84
-	NN3-24S15C3N			15	200/20	105	8	560	150/100	82	85
-	NN3-24S24C3N			24	125/13	97	8	470	150/100	81	84

Note: The ripple & noise are tested by the twisted pair method.

Input Specifications

Item	Operating Condition	Min.	Typ.	Max.	Unit
Input Inrush Voltage (1Sec max.)	5Vdc input	-0.7	--	9	Vdc
	12Vdc input	-0.7	--	18	
	24Vdc input	-0.7	--	30	
Input Filter	Capacitor Filter				

Hot Plug	Unavailable					
Output Specifications						
Item	Operating Condition	Min.	Typ.	Max.	Unit	
Output Power		0.3	--	3	W	
Output Voltage Accuracy	Refer to the Output Voltage Deviation Graph (Figure 1)					
Load Regulation	10% -100% load	3.3V output	--	15	20	%
		Others	--	10	15	
Line Voltage Regulation	Input voltage change $\pm 1\%$	3.3V output	--	--	1.5	--
		Others	--	--	1.2	
Temp. Drift Coefficient	100% Load	--	--	± 0.03	%/ $^{\circ}\text{C}$	
Short Circuit Protection	Continuous, self-recovery					

General Specifications					
Item	Operating Condition	Min.	Typ.	Max.	Unit
Switching Frequency	Nominal input voltage, full load	--	260	--	KHz
Operating Temperature	Refer to the Temperature Derating Graph (Figure 2)	-40	--	+85	$^{\circ}\text{C}$
Storage Temperature		-55	--	+125	
Case temperature rise	$T_a=25^{\circ}\text{C}$	--	30°	--	
Pin soldering	1.5mm from the case, 10S	--	--	300	
Relative Humidity	No condensing	5	--	95	%RH
Isolation Voltage	I/P-O/P, test 1 minute, leakage current $< 1\text{mA}$	3000	--	--	VDC
Insulation Resistance	I/P-O/P, @ 500VDC	1000	--	--	$\text{M}\Omega$
Isolation Capacitor	I/P-O/P, 100KHz/0.1V	--	20	--	pF
Vibration		10-150Hz, 5G, 30 Min. along X, Y and Z			
MTBF	MIL-HDBK-217F@ 25°C	3500	--	--	K hours
Case Material	Plastic in Black, flame class UL94-V0				
Unit Weight	2.5g (Typ.)				
Cooling Method	Natural air				
Packing	Tube size (525x18x10mm)			25PCS/Tube	
	Carton size (542x110x155mm)			2000PCS/Carton (Total 80 Tubes)	
Unit Dimensions	L x W x H	19.50 x 7.00 x 10.10 mm		0.768 x 0.276 x 0.398 inch	

EMC Performance		
EMI	CE	CISPR32/EN55032 CLASS B (with the Recommended EMC circuit)
	RE	CISPR32/EN55032 CLASS B (with the Recommended EMC circuit)
EMS	ESD	IEC/EN61000-4-2 Air $\pm 8\text{kV}$ / Contact $\pm 6\text{kV}$ perf.Criteria B

Mechanical Dimensions

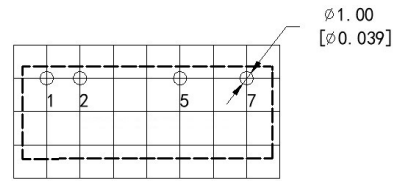
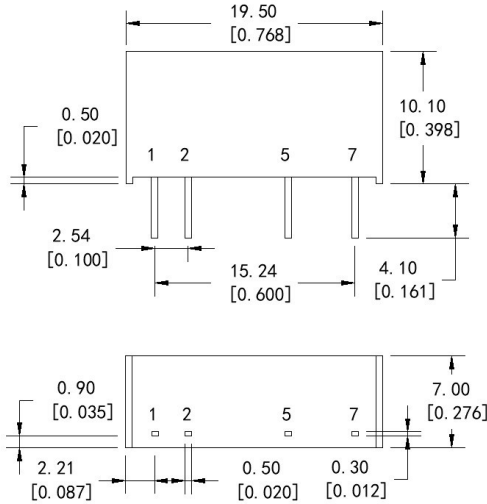

Unit: mm[inch]
 Pin section tolerance $\pm 0.10[\pm 0.004]$
 General tolerance $\pm 0.50[\pm 0.020]$

Pin Function Description

Pin No.	1	2	3	4	5	6	7
Single output	+Vin	GND	No Pin	No Pin	-Vout	No Pin	+Vout

Note - Please take the pin definition on the product label as the right one if there is any difference between the data sheet and the one printed on the product label.

Ripple & Noise Test Instruction (Twisted Pair Method, 20MHZ bandwidth)

1) The Ripple & noise test needs 12# twisted pair cables, an oscilloscope which bandwidth should be set to 20MHz, 0.1uF polypropylene capacitor and 10uF high-frequency low-resistance electrolytic capacitor are connected in parallel with the probes (100M bandwidth). The oscilloscope should be set at the Sample Mode.

2) The test diagram is shown on the right. The converter output connects to the electronic load by the jig with cables which size should be defined according to the output current value. The twisted pair (length 30cm \pm 2 cm) should be connected in parallel with the load, the location is as close as possible to the output pins or terminals. The test can be started after input power on.

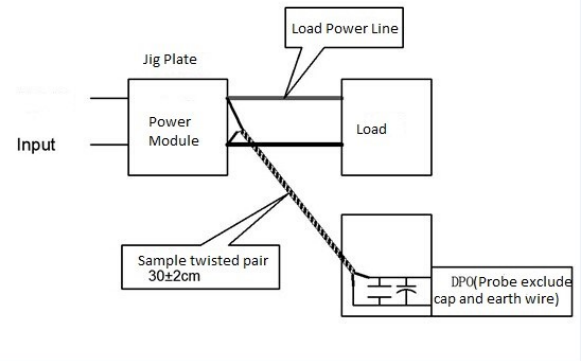

Product Characteristics Graph

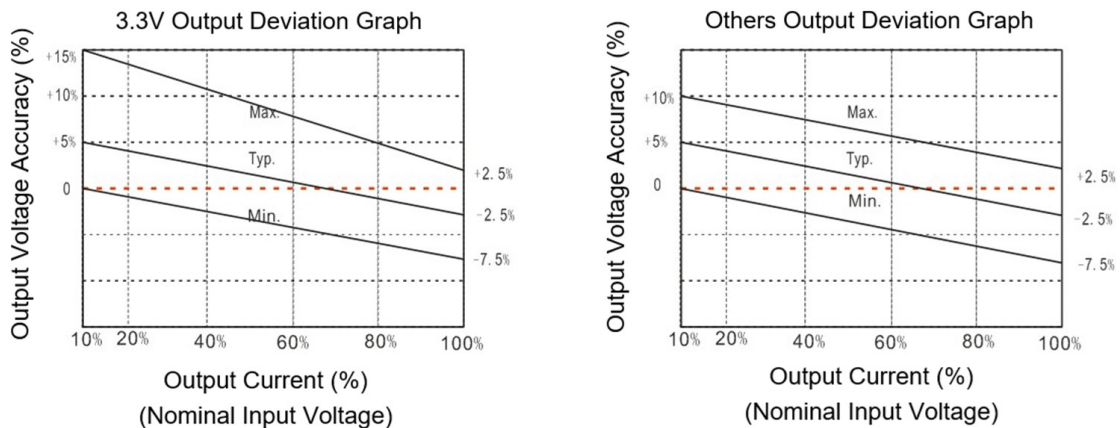

Figure 1

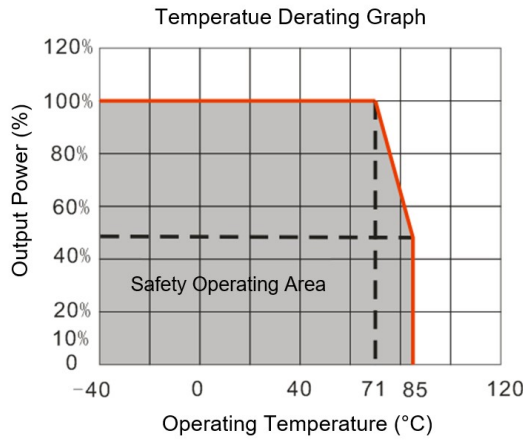
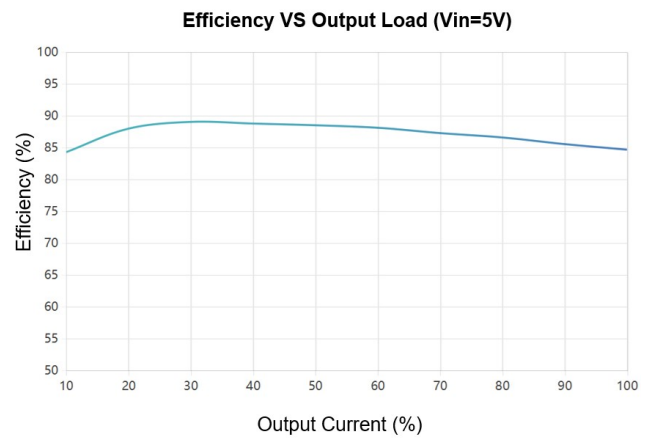
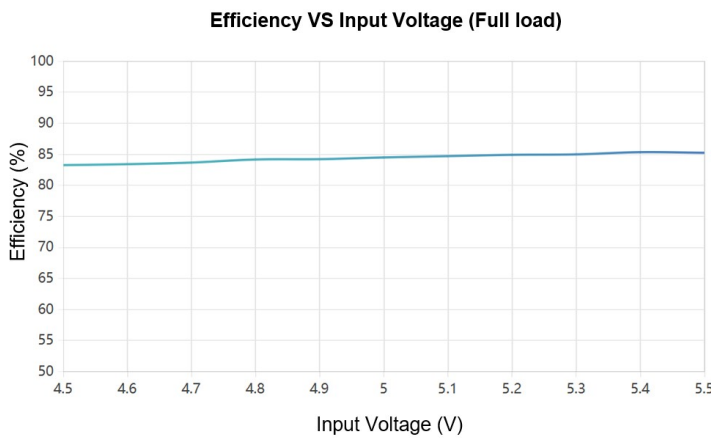

Figure 2



NN3-05SXXC3N

Recommended Circuits for Application

1. Requirement for Output load

The maximum capacitive load was tested at the rated full load. The converter may not start or be damaged if the output capacitors exceed this value.

2. Typical application circuit

To ensure effectively decrease the input and output ripple and noise, a capacitor filter can be connected at the input and output, the application circuit is shown in the figure below. The suitable filter capacitors should be chosen as the recommended capacitive load values in Table 1. The converter could not start if the capacitance is too big.

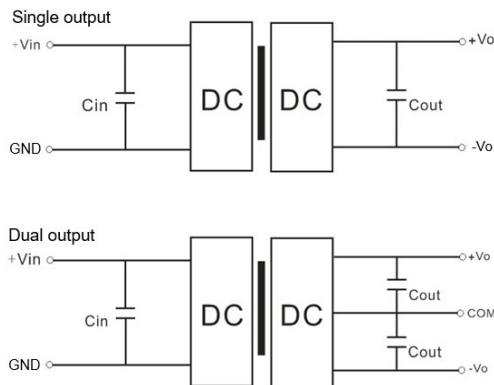

Recommended Capacitive Load Value Table (Table 1)

Vin (Vdc)	Cin	Single Vout (Vdc)	Cout (μF)	Dual Vout (Vdc)	Cout (μF)
5	10 μF/16V	3.3	10 μF/16V	±3.3	4.7 μF/16V
12	2.2 μF/25V	5	10 μF/16V	±5	4.7 μF/16V
15	2.2 μF/25V	9	2.2 μF/25V	±9	2.2 μF/25V
24	1 μF/50V	12	2.2 μF/25V	±12	1 μF/25V
--	--	15	1 μF/25V	±15	1 μF/16V
--	--	24	1 μF/50V	±24	0.47 μF/50V

3. Recommended EMC Circuit

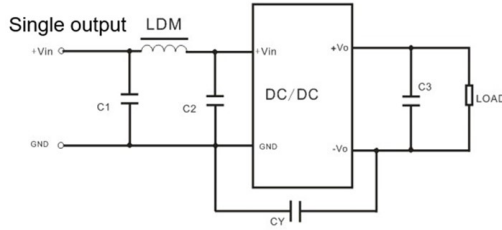

Input voltage		5VDC	12/15/24VDC
EMI	C1/C2	4.7μF/16V	4.7μF/50V
	CY	270pF/4KV	270pF/4KV
	C3	Refer to Cout in Table 1	
	LDM	6.8 μH	6.8 μH

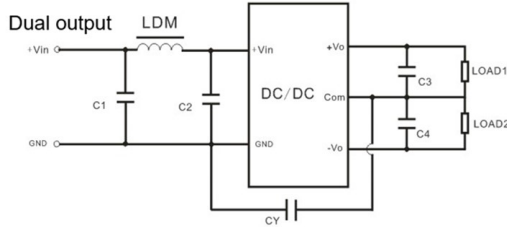

Input voltage		5VDC	12/15/24VDC
EMI	C1/C2	4.7μF/16V	4.7μF/50V
	CY	270pF/4KV	270pF/4KV
	C3/C4	Refer to Cout in Table 1	
	LDM	6.8 μH	6.8 μH

4. Output voltage regulation and overvoltage protection

The simple solution to achieve the output regulated voltage, over voltage and over current protections is to connect a linear regulator with overheat protection at input or output, and a capacitor filter connected in parallel as below circuit. Filter capacitive value recommended see table 1, Linear regulator should be chosen according to the actual voltage & current for operating. Or Aipu NW series products are recommended instead.

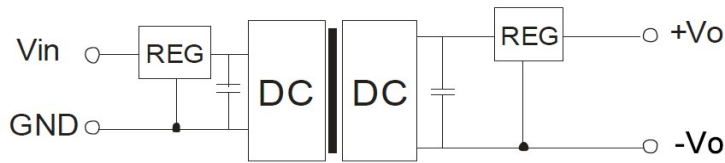

Application Notice

1. This series of converters should not be used in parallel, and they do not support hot-plugging.
2. The product performance in this datasheet cannot be guaranteed if it works at a lower load than the minimum load condition.
3. All values or indicators in this datasheet had been tested based on Aipupower test specifications.

Guangzhou Aipu Electron Technology Co., Ltd

Address: Building 4, HEDY Park, No.63, Punan Road, Huangpu Dist, Guangzhou, China.

Tel: 86-20-84206763 Fax: 86-20-84206762 HOTLINE: 400-889-8821

E-mail: sales@aipu-elec.com Website: <https://www.aipupower.com>